



Serie

S - 350 EUR

Especificaciones Técnicas

Carpintería practicable

Cámara Europea

Junta abierta con Junta Central

Sección de Marco 40 mm.

Sección de Hoja 47 mm.

Galce de vidrio de 7,5 a 34 mm.
Junquillos de altura 20 mm. (Tabla de Acristamiento 1)

Peso Máximo por : Hoja Practicable : 120 Kg.⁽¹⁾

Hoja Oscilo- Batiente : 130 Kg.⁽¹⁾

Hoja Oscilo- Batiente con opción de Herraje Oculto

Medidas Máximas por Hoja para todas las aperturas :
1700 mm. x 2500 mm.⁽¹⁾

(1) Consultar rangos de aplicación con nuestro Dpto. Técnico Comercial

Clasificación obtenida

Permeabilidad al aire*	CLASE	4
Estanqueidad al agua*	CLASE	8A
Resistencia al viento*	CLASE	C4
Transmitancia térmica**		3.8 W/m ² K
Transm. térmica Uf (Nudo lateral) [^]		5.7 W/m ² K
Aislamiento Acústico***		38 (-1;-5)dB

* Ventana de 2 hojas de 1230 x 1480 mm .

** Ventana de 2 hojas de 1480 x 2180 mm ; Vidrio 4-8-4

*** Ventana de 2 hojas de 1230 x 1480 mm ; Vidrio Rw: 40 (-2,-6)dB

[^] Según normativa UNE-EN ISO 10077-2

Posibilidades de Apertura

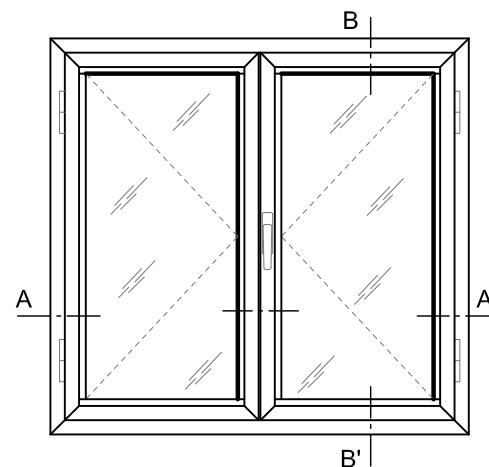
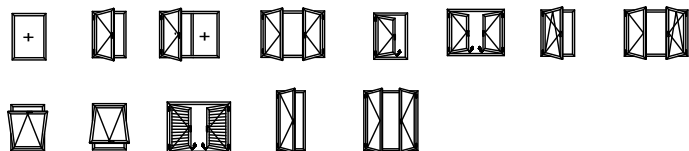

VENTANA 2 HOJAS PRACTICABLES

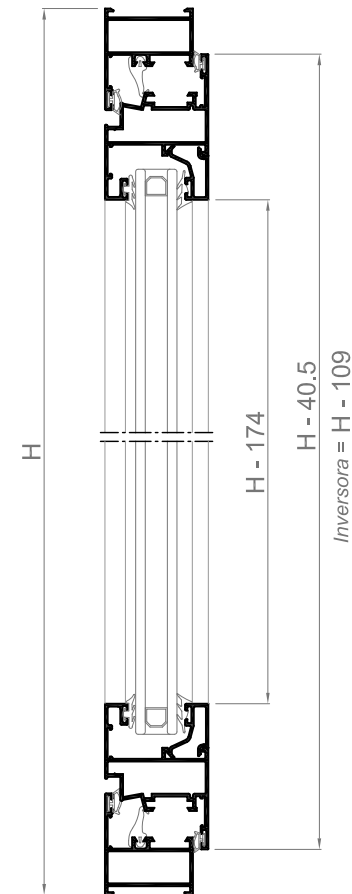

Sección B-B'

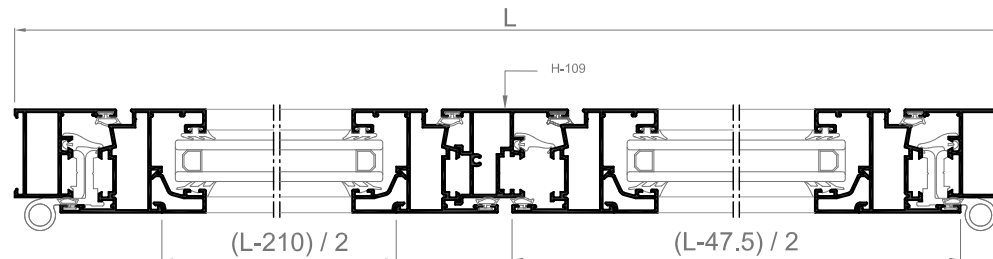

Sección A-A'

Los ensayos de las ventanas realizados por el grupo Alugom, que son cedidos para la obtención del marcado CE por parte del cliente, se han realizado con los perfiles y accesorios específicos y concretos propuestos por el grupo Alugom, que figuran en los manuales de fabricación de cada serie. Para más información consultar con la sección técnico-comercial del grupo Alugom.

Perfiles

S - 350 EUR

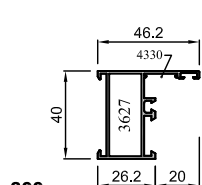

300
3575

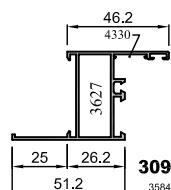

309
3584

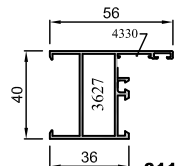

311
3586

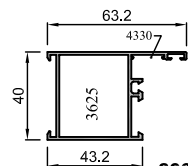

306
3578

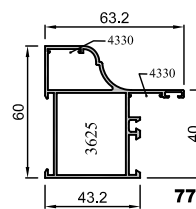

771
3594

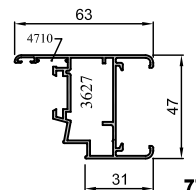

777
3598

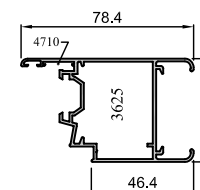

362
3590

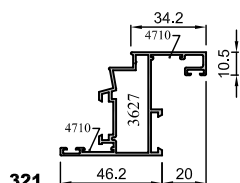

321
3604

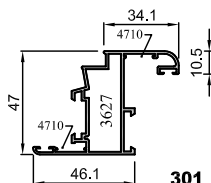

301
3549

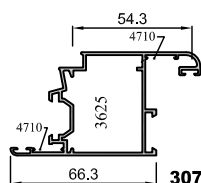

307
3579

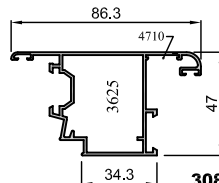

308
3583

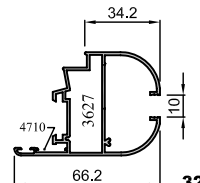

322
3587

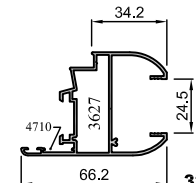

323
3588

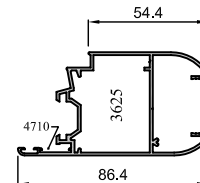

794
3603

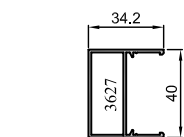

364
3572

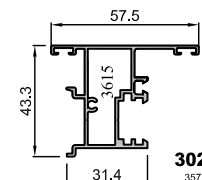

302
3577

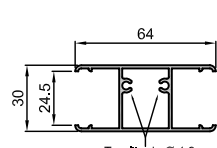

8296

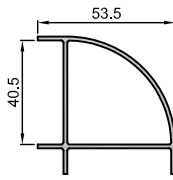

630
6102

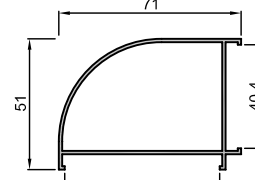

506
6612

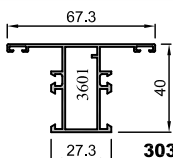

303
3580

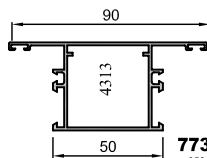

773
3591

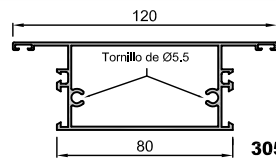

305
3582

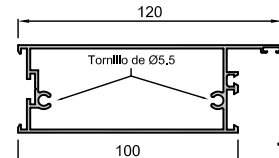

772
3592

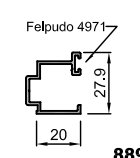

8891

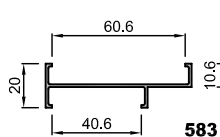

583
6653

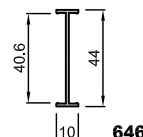

646
6144

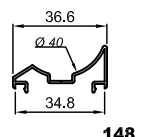

148
2593

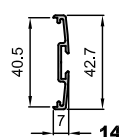

142
2579

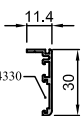

281
1140

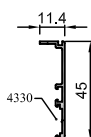

8629

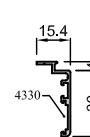

775
3596

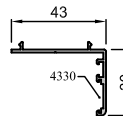

325
3551

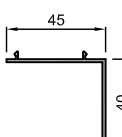

324
3561

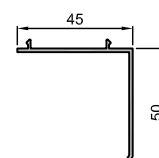

369
3548



8412



8428

Accesorios

S - 350 EUR

Cremonas y Manillas

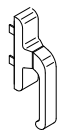

1032
Cremona giro
Alugom

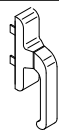

4024
Cremona EURO



4019
Cremona EURO
Os-Ba

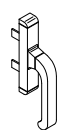

4200
Cremona
Nova



4725
Cremona Prima
Os-Ba



4723
Cremona Prima
Pract.



4792
Cremona Prima
Os-Ba c/llave

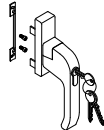

4707
Cremona EURO
c/llave

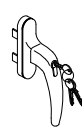

4761
Cremona Prima
con llave

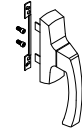

5497
Cremona Asia
Pract.

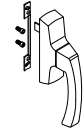

5428/75
Cremona Asia
Os-Ba

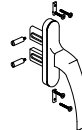

1034
Cremona ap. Ext.
patillas Balcon.

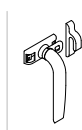

1044
Cierre presión
(Pequeño)

Cremonas y Manillas

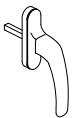

4190
Manilla
cuadradillo 7 mm.

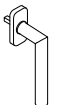

5079
Manilla inox.
recta

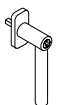

5080
Manilla inox
recta c/llave



5183
Manilla cuadradillo
7 mm c/llave

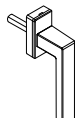

5191
Manilla Kora
c/cuadr. 7mm

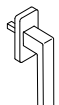

5389
Manilla Toulon
cuadr. 7 mm

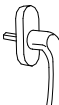

5393
Manilla Plutón
cuadr. 7 mm

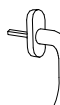

5398
Manilla Atlanta
cuadr. 7 mm.



5436
Manilla Asia
cuadr. 7 mm.

Bisagras

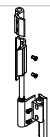

4724
Bisagra Os-Ba
Simétrica 2º Hoja

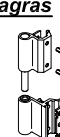

4727
Bisagra Flash
Izquierda/Derecha

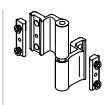

4768
Bisagra
3º Hoja

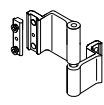

4769
Bisagra Extremo
"Jirafa"



4352
Bisagra ventana
3 hojas

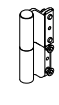

4744
Bisagra Puerta
24,5 mm. Izda.

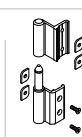

4316
Bisagra apertura
externa

Escuadras



3623
Esc. europea
ventana



3624
Esc. europea
Puerta



3625
Esc. pulsante
Puerta



3626
Esc. pulsante
ventana



3627
Esc. pulsante
descentrada



1237
Esc. pivotes
ventana (An)



1238
Esc. Europea
Puerta (An)



1224
Escuadra ángulo
variable

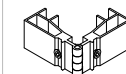

1225
Escuadra ang. variable
Portada



4039
Escuadra inox.
alineamiento



4330
Escuadra
alineam. 15



4710
Esc. alineam.
14 mm.



4735
Escuadra
alineamien.
2 mm.

Mecanismos de Apertura



5081
Mec. Cuadrad.
unidirec. OS-BA

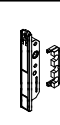

4613
Mec. Cuadrad.
bidirec. pract.



5153
Mec. Cuadrad.
Ap. Externa
Unidirec. 33.5

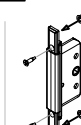

5527
Mec. Cuadrad.
Apert. Externa
Bidirec. 29

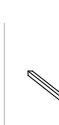

5154
Cuadradillo
7 x 80 mm.



3601
Taco pilastra
ventana

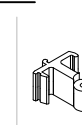

4313
Taco pilastra
ancha

Elementos de Cierre



4739
Terminal pletina
metálico



4002
Pasador oculto
long. variable



4003
Terminal de
pletina cremona



4731
Pasador Inca
2ºH Canal 18



4010
Bisagra compás
corto ralenti



4085
Bisagra compás
largo ralenti



4011
Bisagra compás
regul. proyect.

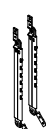

4842
Cerradero sup.
regulable
OS-BA



4720
Cerradero lateral
doble pletina
Zamak



4007
Cierre complem.
cremona



4846
Tercer punto
de cierre



4008
Patín apoyo
hoja

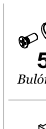

5026
Bulón regulable

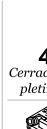

4005
Cerradero lateral
pletina Nylon



5040
Limitador
apertura



4009
Cierre cangrejo
Interno

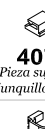

4078
Pieza sujeción
junquillo curvo



2040
Cepillo Vaiten
14 x 12

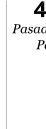

4860
Pasador bidirec.
Palanca

Elementos de Cierre



4025
Kit Cremona
EURO



4840
KIT Pasador hoja
pasiva metá.
(sup. e inf.)



4353
Kit acristalam.
s/junquillo vent.
(2 A + 2 B)



4356
Broca doble
diámetro
(s/junquillo)

Tapas

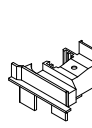

3615
Juego tapajuntas
acople



4994
Tapa rígida
canal

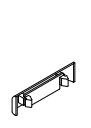

4337
Emb. salida agua
c/membrana



4035
Embellecedor
salida agua

Juntas



4324
Junta
central



3016
Junta Burbuja
aximétrica

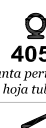

4056
Junta perimetral
hoja tubular



4055
Junta perim.
hoja

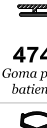

4741
Goma para
batiente



4397
Junta Stilo
base rígida

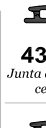

4303
Junta acústica
cerco



4379
Junta acústica
cerco

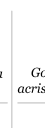

4090
Goma interior
acrist. de 4 a 6mm.



4089
Goma interior
acrist. de 2 a 4mm.



5261
Goma interior
acrist. de 8 a 10 mm.



4091
Goma Interior
acrist. de 6 a 8mm.



4057
Goma exterior
acristamiento

Acc. Varios

4380 Kit Cremona EURO 2 hojas (s/cremona)
4002x2 + 4003x2 + 4025 + 4004x2 + 4008

4714 Kit Cremona EURO 1 hoja (s/cremona)
4002x2 + 4003x2 + 4025 + 4004x2 + 4008

4704 Cremona desm. EURO Away

4705 Manilla EURO extraible

5022 Cremona Industrial Prima

Ver ampliado en pág. s/Índice:

- Accesorios Os-Ba

- Herraje oculto

- KITS Os-Ba

- Cerraduras

Utillaje

3610 Juego fresas S-350 EUR

4841 Útil Múltiple Practicable

Perfiles

S - 350 EUR Mallorca

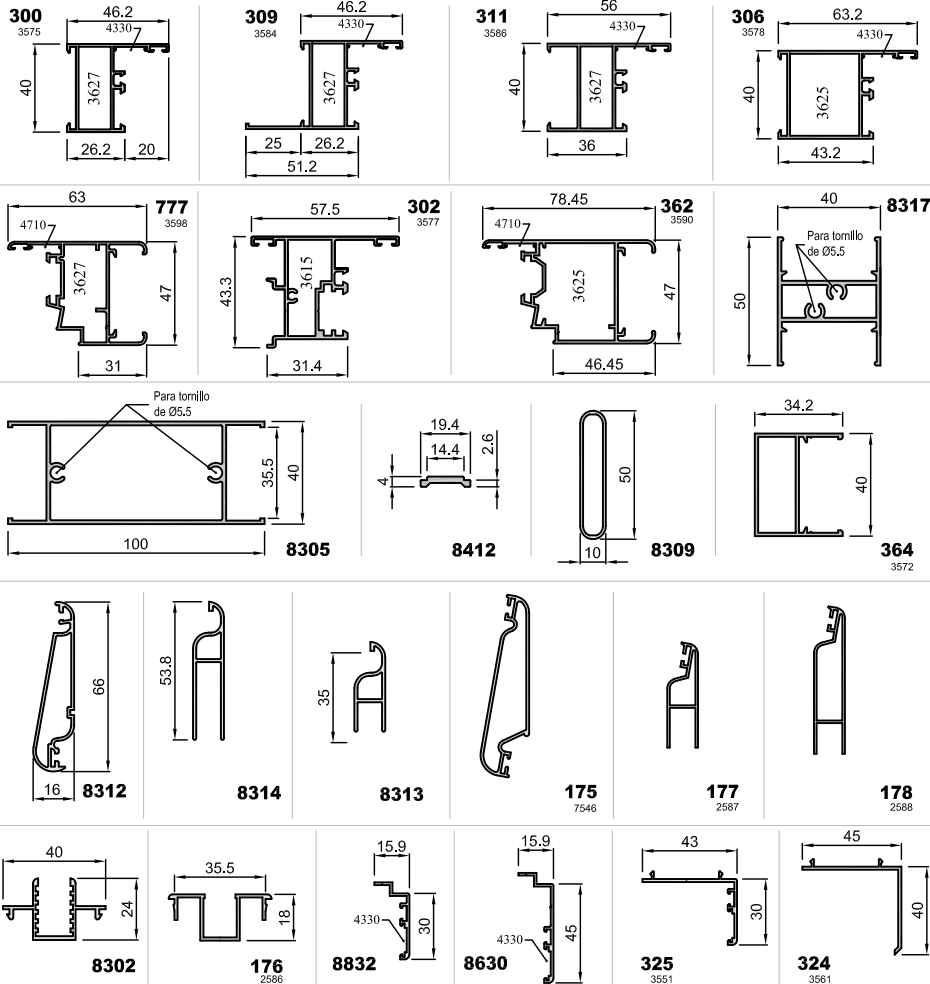

Accesorios

Elementos de cierre

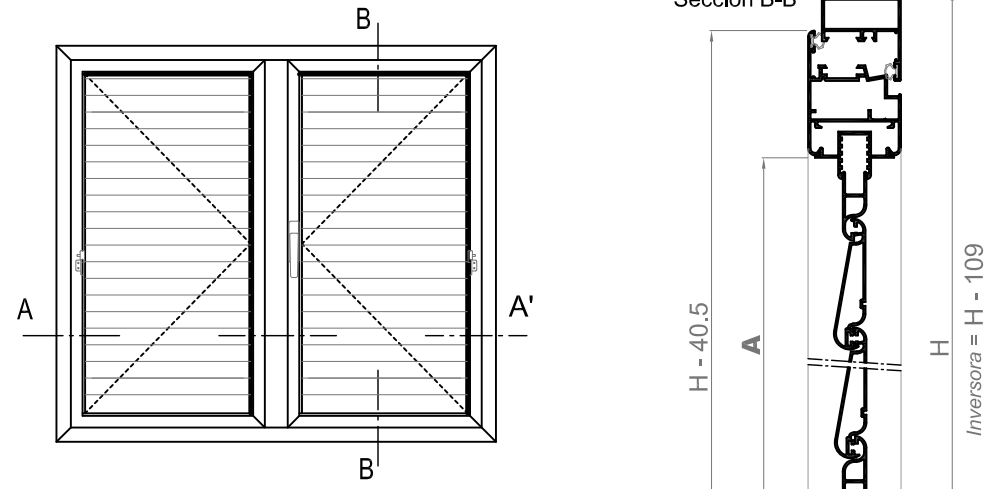
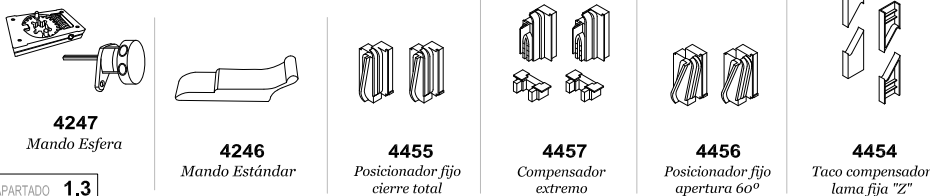

VENTANA 2 HOJAS MALLORQUINAS

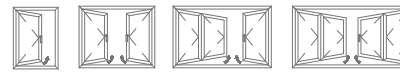

Posibilidades de Apertura

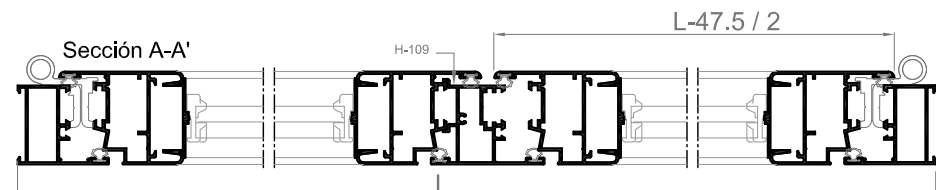

NUNCA MENOS DE 400 mm. DE ANCHO

Ver Instrucciones de Montaje de las Celosías al final de serie Mallorca Corredera

TABLA DE CELOSÍAS					
REF.	Nº DE LAMAS	*A (mm.)	REF.	Nº DE LAMAS	*A (mm.)
4209	UN55 6 LAMAS	387 - 441	4224	UN55 21 LAMAS	1212 - 1266
4210	UN55 7 LAMAS	442 - 496	4225	UN55 22 LAMAS	1267 - 1321
4211	UN55 8 LAMAS	497 - 551	4226	UN55 23 LAMAS	1322 - 1376
4212	UN55 9 LAMAS	552 - 606	4227	UN55 24 LAMAS	1377 - 1431
4213	UN55 10 LAMAS	607 - 661	4228	UN55 25 LAMAS	1432 - 1486
4214	UN55 11 LAMAS	662 - 716	4229	UN55 26 LAMAS	1487 - 1541
4215	UN55 12 LAMAS	717 - 771	4230	UN55 27 LAMAS	1542 - 1596
4216	UN55 13 LAMAS	772 - 826	4231	UN55 28 LAMAS	1597 - 1651
4217	UN55 14 LAMAS	827 - 881	4232	UN55 29 LAMAS	1652 - 1706
4218	UN55 15 LAMAS	882 - 936	4233	UN55 30 LAMAS	1707 - 1761
4219	UN55 16 LAMAS	937 - 991	4234	UN55 31 LAMAS	1762 - 1816
4220	UN55 17 LAMAS	992 - 1046	4235	UN55 32 LAMAS	1817 - 1871
4221	UN55 18 LAMAS	1047 - 1101	4236	UN55 33 LAMAS	1872 - 1926
4222	UN55 19 LAMAS	1102 - 1156	4237	UN55 34 LAMAS	1927 - 1981
4223	UN55 20 LAMAS	1157 - 1211	4238	UN55 35 LAMAS	1982 - 2036

* Altura libre de hueco de hoja

